



art metal

06 ANDROMEDA

F.P.H. Art Metal Sp.j.

Ul. Jabłoniowa 124, 83-331 Łapino Kartuskie, Poland
Tel. 0048 58 681 80 78, Fax: 0048 58 681 80 64
www.art-metal.pl e-mail: biuro@art-metal.pl

Construction:

The unit consists of a lamp body (1) with control gear (3) inside. The control gear is mounted on a tray (2) to a cylindrical reflector (ODB-2) (5). Lampholder (4) is mounted with a lamp (7) inside the reflector. Globe (9) and a gasket (10) is mounted with bolts to the luminary body. The luminary is mounted on the top with a M20 thread.

Mounting instructions:

- *)-Mount the igniter module (3) and the lampholder (4) on the tray (2).
- Place a lamp (7) in the lampholder (4)
- Connect the pole's electrical system to the control gear (3)
- *)-Mount the cylindrical reflector (5) with control gear (3) to the luminary body (1).
- Use the bolts with the clips (11) to fix the gasket (10), ring (8) and the shade (9) in position.

If any lantern elements are supplied factory-mounted, the mounting stages marked with *) should be omitted (as this has already been done by the manufacturer)

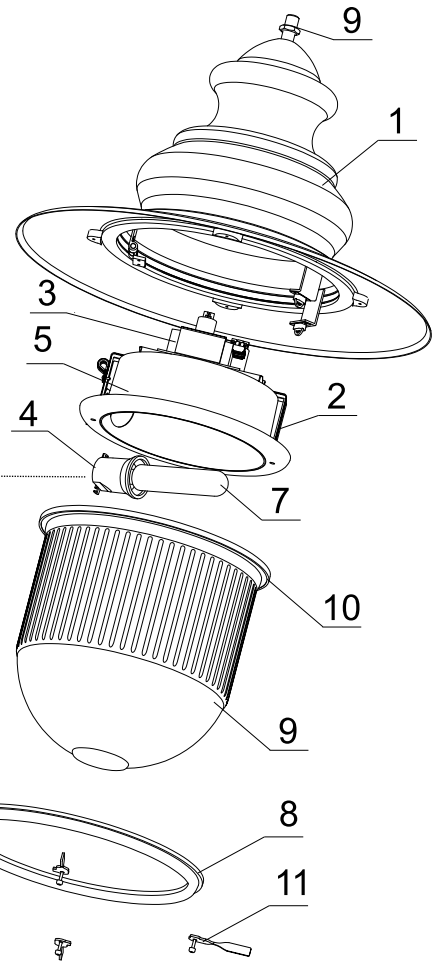

TECHNICAL DATA:

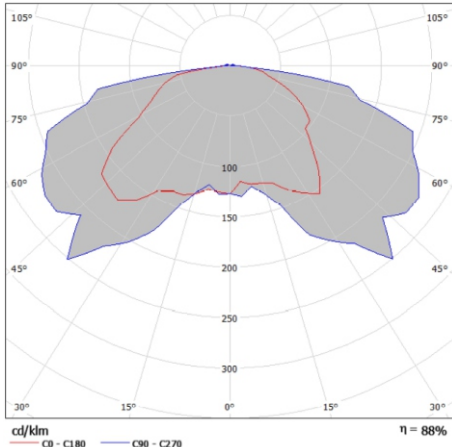

Power: ~230/50Hz

Protective class: I

IP44 - electrical part

IP66 - optical part

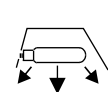
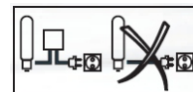

ELECTRICAL DIAGRAM:

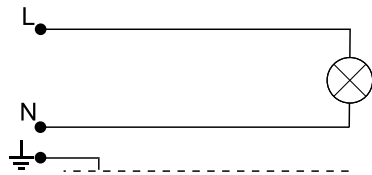

1. Incandescent bulb

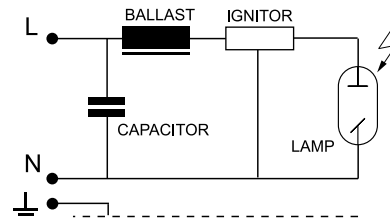

2. Sodium / metal halide lamps

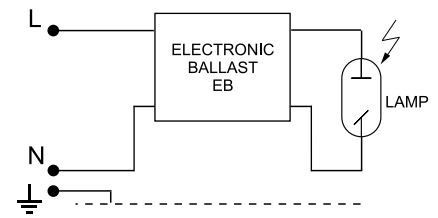

3. Sodium / metal halide lamps

Type	Light-producing element	Lamp holder	Weight [kg]	Pn [W]		Luminary dimensions	
				IC	EB	Wind area A = 0,22m ²	L/D 750/700
06MH-70W	MH/HSI/HPI	E27	11,5	81	75		
06MH-100W	MH/HSI/HPI	E27	12,0	114	105		
06MH-150W	MH/HSI/HPI	E27	12,7	169	155		
06MH-250W	MH/HSI/HPI	E40	13,7	273	255		
06S-70W	WLS/SHP/SON	E27	11,5	81	75		
06S-100W	WLS/SHP/SON	E40	12,0	114	105		
06S-150W	WLS/SHP/SON	E40	12,7	169	155		
06S-250W	WLS/SHP/SON	E40	13,7	279	255		
06Z-E/Z	Bulb / MINI - LINX	E27	10,0	Maks. 60			

WARNING !! The weight of the unit may slightly differ for individual production batches.

Sign:L-0006-01-04

Last revision: 2017.01.04

